

Цанговые фитинги из технополимера

Тесно-RAP

РАБОЧЕЕ ДАВЛЕНИЕ от -0,9 до 12 бар
ТЕМПЕРАТУРА ЭКСПЛУАТАЦИИ от -20° до +60 °С

Фитинги цанговые серии Тесно-RAP предназначены для быстрого соединения пластиковых воздушных трубок с различными пневматическими элементами. Цанговые фитинги обладают большим количеством форм, малым весом и высокой коррозионной стойкостью. Присоединение и разъединение трубки цанговыми фитингами повторяется многократно без использования инструментов.

Присоединение цанговыми фитингами: резьба метрическая М5, М6, М10 и трубная цилиндрическая G1/8"...1/2" по ISO 228 (BSP) и коническая R1/8"...1/2" по ISO 7 (BSPT), трубка полимерная диаметром \varnothing 4...14 мм.

1 Вспомогательное кольцо

2 Цанга

3 Блокирующее кольцо

4 Нажимное кольцо

5 Уплотнения

6 Поворотное основание

7 Корпус фитинга

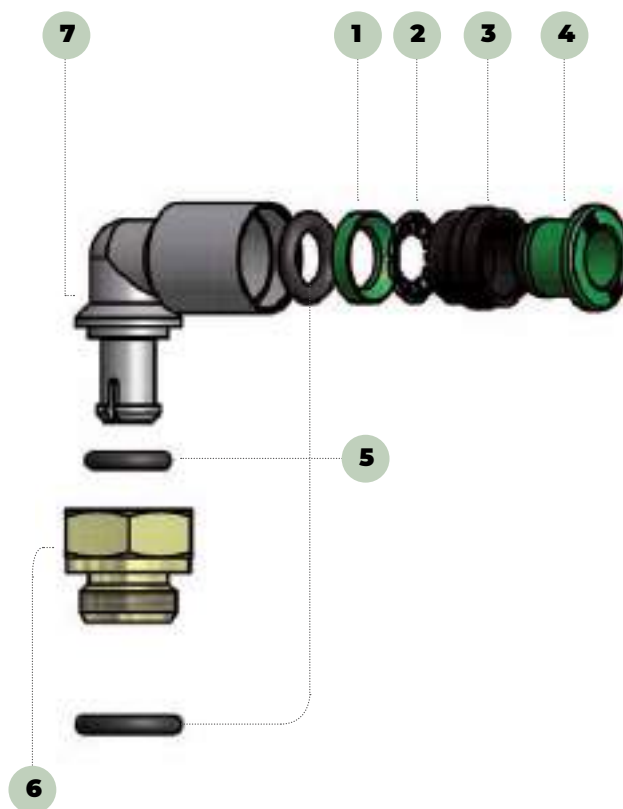

Арт. T01

Код	ØD	G	ØC	ØB	H	L			
T0104M10	4	M10x1,5	2,5	14,0	7,5	21,3	10	2,5	50
T010418	4	1/8	2,5	14,0	5,5	19,0	10	2,5	50
T010414	4	1/4	2,5	17,5	6,5	20,8	10	2,5	50
T0106M10	6	M10x1,5	4,0	14,0	7,5	26,8	12	4,0	50
T010618	6	1/8	4,0	14,0	5,5	24,5	12	4,0	50
T010614	6	1/4	4,0	17,5	6,5	26,0	12	4,0	50
T0108M10	8	M10x1,5	6,0	14,0	7,5	28,1	14	5,0	50
T010818	8	1/8	5,0	14,0	5,5	25,7	14	5,0	50
T010814	8	1/4	6,0	17,5	6,5	27,2	14	6,0	50
T011014	10	1/4	7,0	17,5	6,5	28,7	18	7,0	50

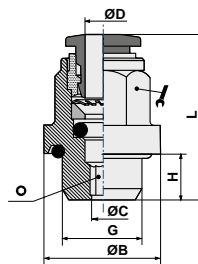

Арт. T03

Код	ØD	ØD1	ØC	ØB	ØB1	L	
T030400	4	4	3	9,5	9,5	32,0	50
T030406	4	6	3	9,5	11,5	32,5	50
T030600	6	6	5	11,5	11,5	35,6	50
T030608	6	8	5	11,5	13,5	36,0	50
T030800	8	8	7	13,5	13,5	38,0	50
T030810	8	10	7	13,5	17,5	32,5	50
T031000	10	10	9	17,5	17,5	42,3	50
T031012	10	12	9	17,5	20,0	44,0	50
T031200	12	12	10	20,0	20,0	46,2	25

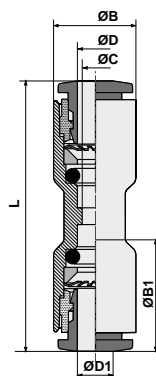

Арт. T04

Код	ØD	ØC	ØB	L	ØE	
T040400	4	3	9,5	17,2	3,2	50
T040600	6	5	11,5	20,8	3,2	50
T040800	8	7	13,5	23,0	3,2	50
T041000	10	9	17,0	26,4	4,3	50
T041200	12	10	20,0	28,9	4,2	25

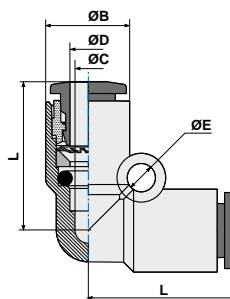

Арт. T04L0

Код	ØD	ØC	ØB	L	L1	ØA	L2	
T0404L0	4	3	9,5	17,2	20,75	4	16,7	50
T0406L0	6	5	11,5	20,8	24,25	6	19,5	50
T0408L0	8	7	13,5	23,0	27,25	8	21,0	50
T0410L0	10	9	17,0	26,4	31,80	10	24,0	50
T0412L0	12	10	20,0	28,9	36,00	12	25,0	25

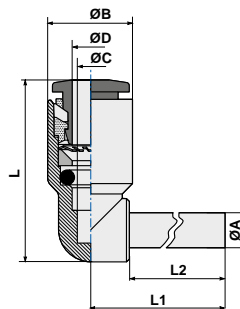

ГИДРАВЛИЧЕСКОЕ ОБОРУДОВАНИЕ

ПНЕВМАТИЧЕСКОЕ ОБОРУДОВАНИЕ

СИСТЕМЫ СМАЗКИ

Арт. T05

Код	ØD	ØD1	ØC	ØB	L	
T050400	4	4	3,0	9,5	17,2	50
T050604	6	4	5,3	13,0	19,2	50
T050600	6	6	5,0	11,5	20,8	50
T050806	8	6	7,1	14,4	22,7	25
T050800	8	8	7,0	13,5	23,0	50
T051008	10	8	9,3	18,4	27,9	25
T051000	10	10	9,0	17,0	26,4	25
T051210	12	10	10,0	21,0	29,9	10
T051200	12	12	10,0	20,	28,9	10

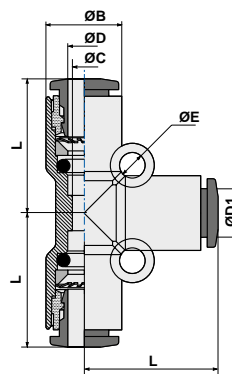

Арт. T05L0

Код	ØD	ØC	ØB	L	L1	ØA	L2	
T0504L0	4	3	9,5	17,2	20,75	4	16,7	50
T0506L0	6	5	11,5	20,8	24,25	6	19,5	50
T0508L0	8	7	13,5	23,0	27,25	8	21,0	50
T0510L0	10	9	17,0	26,4	31,80	10	24,0	25
T0512L0	12	10	20,0	28,9	36,00	12	25,0	10

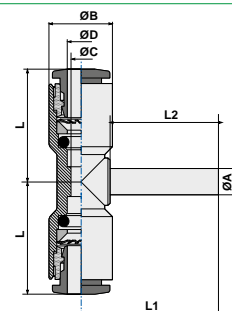

Арт. T05V0

Код	ØD	ØB	L	L1	ØA	L2	
T0504V0	4	9,5	17,2	20,75	4	16,7	50
T0506V0	6	11,5	20,8	24,25	6	19,5	50
T0508V0	8	13,5	23,0	27,25	8	21,0	50
T0510V0	10	17,0	26,4	31,80	10	24,0	25
T0512V0	12	20,0	28,9	36,00	12	25,0	10

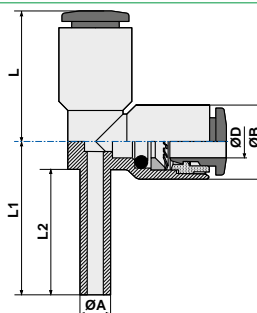

Арт. T08

Код	ØD1	ØD	ØC	ØB	L	L1	
T080604	6	4	3	9,5	35,5	19,5	50
T080804	8	4	3	9,5	37,0	21,0	50
T081004	10	4	3	9,5	40,0	24,0	25
T081204	12	4	3	9,5	41,0	25,0	25
T080806	8	6	5	11,5	39,05	23,0	50
T081006	10	6	5	11,5	42,05	25,0	25
T081206	12	6	5	11,5	43,05	25,0	25
T081008	10	8	7	13,5	43,0	26,25	25
T081208	12	8	7	13,5	44,0	25,0	25
T081210	12	10	9	17,0	46,15	27,55	25

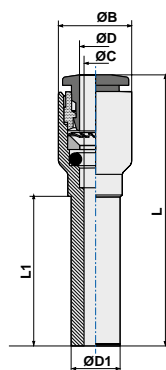

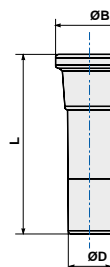

Арт. T09

Код	ØD	ØB	L	
T090400	4	7,0	25,0	100
T090600	6	9,5	27,0	100
T090800	8	12,0	30,0	100
T091000	10	14,0	32,0	100
T091200	12	16,0	35,0	100



Арт. T10

Код	ØD	ØC	L	M	lmax		
T100400	4	9,5	32,0	11x1	8	14	50
T100600	6	11,5	36,1	14x1	8	17	50
T100800	8	13,5	38,0	16x1	10	18	25
T101000	10	17,5	42,3	20x1	12	24	25
T101200	12	20,0	46,2	22x1	17	26	25

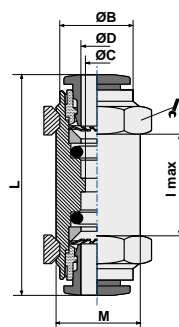

Арт. T10L

Код	ØD	M	B	E	H	L max	CH	
T10L0400	4	12x1	28,5	19,0	14	6	14	50
T10L0600	6	14x1	32,1	19,2	17	7	17	50
T10L0800	8	16x1	39,4	23,0	19	7,5	19	25
T10L1000	10	20x1	44,8	28,2	24	9,5	24	25
T10L1200	12	22x1	46,6	29,5	27	10	26	25

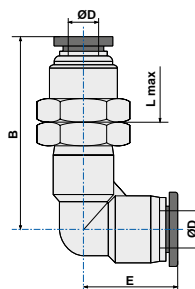

Арт. T11

Код	ØD	ØB	ØA	C	
T110400	4	9,5	17,2	3	25
T110600	6	11,5	20,8	3	25
T110800	8	13,5	23,0	3	25
T111000	10	17,0	6,4	3	10
T111200	12	20,0	28,8	3	10

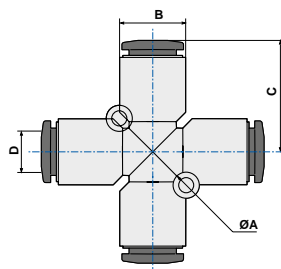

Арт. T13

Код	ØD	G*	ØC	ØB	ØA	H	L	ØF	
T1304M5	4	M5	3	9,5	5	10	19,5	8,0	50
T130418	4	1/8	3	9,5	9,9	15	21,1	14,0	50
T130618	6	1/8	5	11,5	9,9	15	24,3	14,0	50
T130614	6	1/4	5	11,5	13,3	17	25,5	18,0	50
T130818	8	1/8	7	13,5	9,9	15	24,8	14,0	50
T130814	8	1/4	7	13,5	13,3	17	25,5	18,0	50
T130838	8	3/8	7	13,5	16,75	20	28,0	14,0	50
T131014	10	1/4	9	17,0	13,3	17	28,4	18,0	50
T131038	10	3/8	9	17,0	16,75	20	29,9	21,3	25
T131012	10	1/2	9	17,0	13,3	24	30,0	26,0	25
T131238	12	3/8	10	20,0	16,75	20	31,4	21,3	25
T131212	12	1/2	10	20,0	21	24	34,9	26,0	25
T13R04M5	4	M5	3	9,5	6	10	19,5	8	50
T13R06M5	6	M5	20,0	11,5	6	10	23	8	50

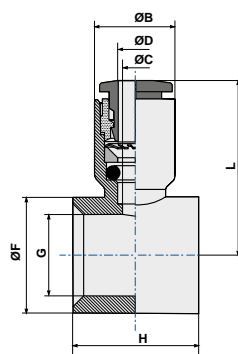

*Присоединение пустотелого болта

Арт. T13B

Код	ØD	G*	ØB	ØA	H	ØF	
T13B04M5	4	M5	10	19,5	19	50	50
T13B0618	6	1/8	15	24,3	23	50	50
T13B0814	8	1/4	17	26,5	27	50	50
T13B1038	10	3/8	20	29,9	34	25	50
T13B1212	12	1/2	24	34,9	40	10	50

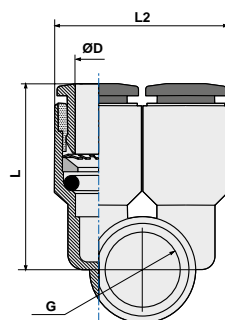

*Присоединение пустотелого болта

ГИДРАВЛИЧЕСКОЕ ОБОРУДОВАНИЕ

ПНЕВМАТИЧЕСКОЕ ОБОРУДОВАНИЕ

СИСТЕМЫ СМАЗКИ

Арт. T14

Код	ØD	G*	ØC	ØB	H	ØF	L	
T1404M5	4	M5	3	9,5	10	8,0	19,5	50
T140418	4	1/8	3	9,5	15	14,0	21,1	50
T140814	8	1/4	7	13,5	17	18,0	26,5	50
T140838	8	3/8	7	13,5	20	21,3	28,0	25
T141014	10	1/4	9	17,0	17	18,0	28,4	50
T141038	10	3/8	9	17,0	20	21,3	29,9	25
T141012	10	1/2	9	17,0	24	26,0	30,0	10
T141238	12	3/8	10	20,0	20	21,3	31,4	25
T141212	14	1/2	10	20,0	24	26,0	34,9	10

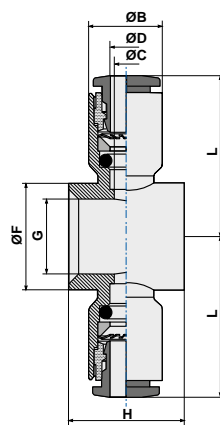

*Присоединение пустотелого болта

Арт. T15

Код	ØD	G	ØA	H	L1	L	Ø	
T1504M5	4	M5	2,0	4,0	17,8	19,5	2,5	50
T1504M6	4	M6	2,0	5,0	18,9	19,5	2,5	50
T150418	4	1/8	5,5	5,5	24,5	21,1	3,0	50
T150618	6	1/8	5,5	5,5	24,5	24,3	3,0	50
T150614	6	1/4	7,8	6,5	28,0	25,5	4,0	50
T150818	8	1/8	5,5	5,5	24,5	24,8	3,0	50
T150814	8	1/4	7,8	6,5	28,0	26,5	4,0	50
T150838	8	3/8	10,0	7,5	32,5	28,0	5,0	25
T151014	10	1/4	7,8	6,5	28,0	28,4	4,0	25
T151038	10	3/8	10,0	7,5	32,5	29,9	5,0	25
T151012	10	1/2	12,0	9,0	38,8	30,0	8,0	10
T151238	12	3/8	10,0	7,5	32,5	31,4	5,0	10
T151212	12	1/2	12,0	9,0	38,8	34,9	8,0	10

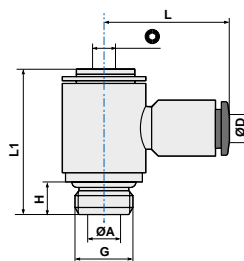

Арт. T15C

Код	ØD	R	A	L	ØK	E		
T15C0418	4	1/8	7,5	23,0	14,4	23,5	12	50
T15C0618	6	1/8	7,5	23,0	14,4	24,0	12	50
T15C0614	6	1/4	9,5	26,5	18,3	25,4	14	50
T15C0638	6	3/8	10,5	32,0	22,0	29,5	19	25
T15C0818	8	1/8	7,5	23,0	14,4	28,9	14	50
T15C0814	8	1/4	9,5	26,5	18,3	29,1	14	50
T15C0838	8	3/8	10,5	32,0	22,0	30,0	19	25
T15C1014	10	1/4	9,5	26,5	18,3	33,0	14	25
T15C1038	10	3/8	10,5	32,0	22,0	33,5	19	25
T15C1012	10	1/2	13,5	38,5	28,0	36,5	24	10
T15C1238	12	3/8	10,5	32,0	22,0	35,8	19	10
T15C1212	12	1/2	13,5	38,5	28,0	36,8	24	10

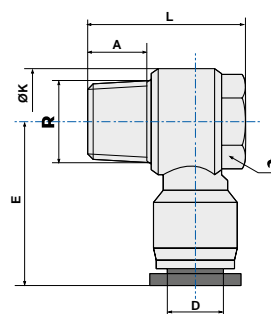

Арт. T15FC

Код	ØD	G/G1	L1	A1	B	ØK		
T15FC0418	4	1/8	23,5	7,5	29	14,4	14	50
T15FC0414	4	1/4	25,5	9,7	35	18,3	17	50
T15FC0618	6	1/8	24,0	7,5	29	14,4	14	50
T15FC0614	6	1/4	25,4	9,5	35	18,3	17	50
T15FC0818	8	1/8	26,5	7,5	29	14,4	14	50
T15FC0814	8	1/4	28,9	9,5	35	18,3	17	50
T15FC0838	8	3/8	30,0	10,5	40	22,0	21	25
T15FC1014	10	1/4	33,0	13,5	35	22,0	21	25
T15FC1038	10	3/8	33,5	10,5	40	28,0	24	25
T15FC1012	10	1/2	36,5	13,5	47,5	18,3	17	10
T15FC1238	12	3/8	35,5	10,5	40	22,0	21	10
T15FC1212	12	1/2	36,5	13,5	47,5	28,0	24	10

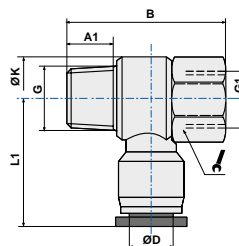

Арт. T15B

Код	ØD	G	ØA	H	L1	L		
T15B04M5	4	M5	2,0	4,0	17,5	19,5	2,5	50
T15B0618	6	1/8	5,5	5,5	24,5	24,3	3,0	50
T15B0814	8	1/4	7,8	6,5	28,0	26,5	4,0	50
T15B1038	10	3/8	10,0	7,5	32,5	29,9	5,0	25
T15B1212	12	1/2	12,0	9,0	28,8	34,9	8,0	10

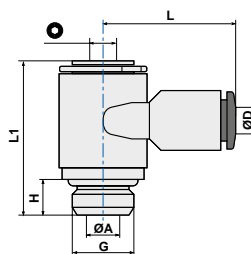

Арт. T16

Код	ØD	G	ØA	H	L1	L		
T1604M5	4	M5	2,0	4,0	17,5	19,5	2,5	50
T160418	4	1/8	5,5	5,5	24,5	21,1	3,0	50
T160814	8	1/4	7,8	6,5	28,0	26,5	4,0	50
T160838	8	3/8	10,0	7,5	32,5	28,0	5,0	25
T161014	10	1/4	7,8	6,5	28,0	28,4	4,0	25
T161038	10	3/8	10,0	7,5	32,5	29,9	5,0	25
T161012	10	1/2	12,0	9,0	38,8	30,0	8,0	10
T161238	12	3/8	10,0	7,5	32,5	31,4	5,0	25
T161212	12	1/2	12,0	9,0	28,8	34,9	8,0	10

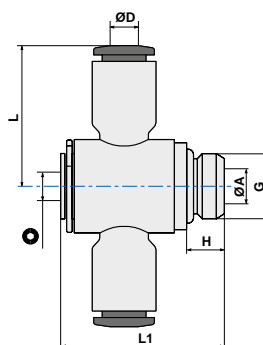

Арт. T18

Код	ØD	ØD1	J	B	Ød	F2	
T180604	6	4	22	58,0	3,2	36	25
T180804	8	4	26	63,4	3,2	42	25
T180806	8	6	26	63,4	3,2	42	25
T181006	10	6	29	83,8	4,2	48	10
T181008	10	8	29	83,6	4,2	48	10

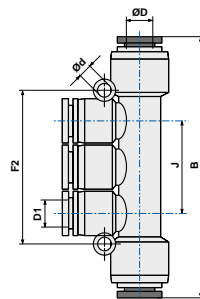

ГИДРАВЛИЧЕСКОЕ ОБОРУДОВАНИЕ

ПНЕВМАТИЧЕСКОЕ ОБОРУДОВАНИЕ

СИСТЕМЫ СМАЗКИ

Арт. T18C

Код	ØD	D1	G	A	B	J		Ød	
T18G0418	4	4	1/8	5,5	68	26	14	3,2	25
T18G0414	4	4	1/4	7,5	70	26	17	3,2	25
T18G0438	4	4	3/8	7,5	70	26	20	3,2	10
T18G0618	6	6	1/8	5,5	68	26	14	3,2	25
T18G0614	6	6	1/4	7,5	70	26	17	3,2	25
T18G0638	6	6	3/8	7,5	70,5	26	20	3,2	10
T18G0612	6	6	1/2	7,5	73	26	24	3,2	10
T18G0818	8	8	1/8	9	87	29	14	3,2	10
T18G0814	8	8	1/4	5,5	89	29	17	3,2	10
T18G0838	8	8	3/8	7,5	89,5	29	20	3,2	10
T18G0812	8	8	1/2	7,5	92,5	29	24	3,2	10
T18G1018	10	10	1/8	9	95,5	37	14	4,2	10
T18G1014	10	10	1/4	5,5	98	37	17	4,2	10
T18G1038	10	10	3/8	7,5	98,5	37	20	4,2	10
T18G1012	10	10	1/2	7,5	101,5	37	24	4,2	10

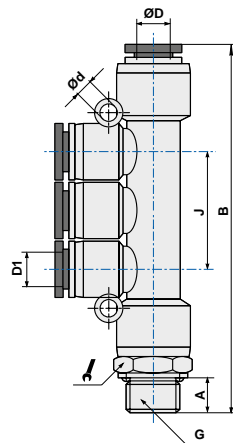

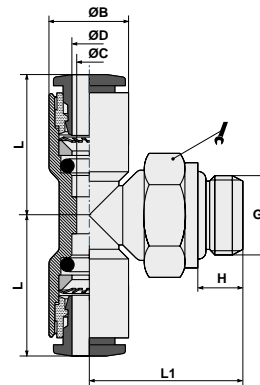

Арт. T20

Код	ØD	G	ØB	H	L	L1		
T2004M3	4	M3	9,5	3,0	17,2	15,0	8	50
T2004M5	4	M5	9,5	4,0	17,2	17,0	8	50
T200418	4	1/8	9,5	5,5	17,2	18,5	13	50
T200414	4	1/4	9,5	7,5	17,2	20,4	16	50
T200438	4	3/8	11,0	7,5	19,0	27,3	20	25
T2006M5	6	M5	9,5	4,0	20,8	17,0	8	50
T200618	6	1/8	11,5	5,5	20,8	18,5	13	50
T200614	6	1/4	11,5	7,5	20,8	20,4	16	50
T200638	6	3/8	13,0	7,5	19,5	27,5	20	25
T200612	6	1/2	13,0	9	19,5	30,0	24	10
T200818	8	1/8	13,5	5,5	23,0	20,0	13	50
T200814	8	1/4	13,5	6,5	23,0	20,4	16	50
T200838	8	3/8	13,5	7,5	23,0	24,8	18	25
T200812	8	1/2	15,0	9	22,5	32,5	24	10
T201018	10	1/8	19,0	5,5	28,5	32,3	17	25
T201014	10	1/4	17,0	7,5	26,4	23,2	16	25
T201038	10	3/8	19,0	10,5	28,5	38,0	17	25
T201012	10	1/2	17,0	9	26,4	31,1	21	10
T201218	12	1/8	21,5	5,5	29,5	33,5	27	10
T201214	12	1/4	21,5	7,5	29,5	38,5	21	10
T201238	12	3/8	20,0	7,5	28,9	26,3	18	10
T201212	12	1/2	20,0	9	28,9	29,3	21	10



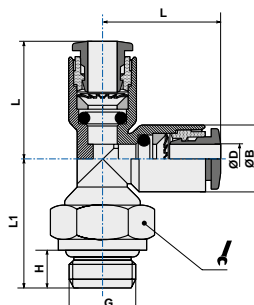

Арт. T21

Код	ØD	G	ØB	H	L	L1		
T2104M3	4	M3	9,5	3,0	12,2	15,0	8	50
T2104M5	4	M5	9,5	4,0	12,2	17,0	8	50
T210418	4	1/8	9,5	5,5	17,2	18,5	13	50
T210414	4	1/4	9,5	7,5	17,2	20,4	16	50
T210438	4	3/8	11,0	7,5	19,0	27,3	20	25
T210618	6	1/8	11,5	5,5	20,8	18,5	13	50
T210614	6	1/4	11,5	7,5	20,8	20,4	16	50
T210638	6	3/8	13,0	7,5	19,7	27,5	20	25
T210612	6	1/2	13,0	9	19,7	30	24	10
T210818	8	1/8	13,5	5,5	23,0	20,0	13	50
T210814	8	1/4	13,5	7,5	23,0	20,4	16	50
T210838	8	3/8	13,5	9	23,0	24,8	18	25
T210812	8	1/2	14,4	9	22,5	32,5	24	10
T211018	8	1/8	19,0	5,5	27,8	32,5	17	25
T211014	10	1/4	17,0	6,5	26,4	23,2	16	25
T211038	10	3/8	19,0	7,5	28,5	38,5	17	25
T211012	10	1/2	17,0	9	26,4	31,1	21	10
T211218	10	1/8	21,0	5,5	29,5	33,5	21	25
T211214	12	1/4	21,0	7,5	29,5	36	21	10
T211238	12	3/8	20,0	7,5	28,9	26,3	18	10
T211212	12	1/2	20,0	9	28,9	31,1	21	10



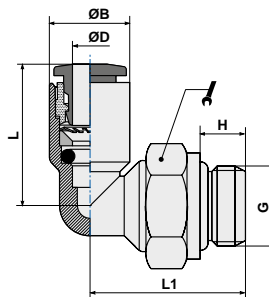

Арт. T22

Код	ØD	G	ØB	H	L	L1		
T2204M3	4	M3	9,5	3,0	17,2	17,0	8	50
T2204M5	4	M5	9,5	4,0	17,2	17,0	8	100
T220418	4	1/8	9,5	5,5	17,2	18,5	13	100
T220414	4	1/4	9,5	6,5	17,2	20,4	16	100
T2206M5	6	M5	11,5	4,0	20,8	17	8	100
T220618	6	1/8	11,5	5,5	20,8	18,5	13	100
T220614	6	1/4	11,5	6,5	20,8	20,4	16	100
T220818	8	1/8	13,5	5,5	23	20	13	100
T220814	8	1/4	13,5	6,5	23	20,4	16	100
T220838	8	3/8	13,5	7,5	23	24,8	18	50
T221018	10	1/8	19	5,5	27,8	26	14	50
T221014	10	1/4	17	6,5	26,4	23,2	16	50
T221038	10	3/8	17	7,5	26,4	24,8	18	50
T221012	10	1/2	17	9	26,4	31,1	21	25
T221214	12	1/4	20	6,5	28,9	24,2	16	25
T221238	12	3/8	20	7,5	28,9	26,3	18	25
T221212	12	1/2	20	9	28,9	31,1	21	25



Арт. T22T

Код	ØD	G	ØB	H	L	L1		
T22T0418	4	1/8	9,5	5,5	17,2	18,5	14	100
T22T0414	4	1/4	9,5	6,5	17,2	20,4	16	100
T22T0618	6	1/8	11,5	5,5	20,8	18,5	14	100
T22T0614	6	1/4	11,5	6,5	20,8	20,4	16	100
T22T0818	8	1/8	13,5	5,5	23,0	20,0	14	100
T22T0814	8	1/4	13,5	6,5	23,0	20,4	16	50
T22T1014	10	1/4	17,0	6,5	26,4	23,2	16	50
T22T1214	12	1/4	20,0	6,5	28,9	24,2	16	50

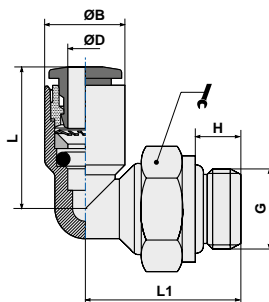

* Снимается с производства, перед заказом уточнить наличие на складе

Арт. T22C

Код	ØD	R	ØB	H	L	L1		
T22C0418	4	1/8	11,5	7,5	17,2	20,5	13	100
T22C0414	4	1/4	11,5	9,5	19,0	20,0	14	100
T22C0438	4	3/8	11,5	10,5	19,0	21,0	17	25
T22C0618	6	1/8	13,5	7,5	19,2	21,5	13	100
T22C0614	6	1/4	13,5	9,5	19,2	21,0	14	100
T22C0638	6	3/8	13,5	10,5	19,2	22,0	17	25
T22C0612	6	1/2	13,5	13,5	19,2	25,5	21	10
T22C0818	8	1/8	15,0	7,5	22,5	22,2	13	100
T22C0814	8	1/4	15,0	9,5	22,5	21,7	14	100
T22C0838	8	3/8	15,0	10,5	23,0	22,7	17	50
T22C0812	8	1/2	15,0	13,5	22,5	26,2	21	10
T22C1018	10	1/8	19,0	7,5	26,9	26,9	13	50
T22C1014	10	1/4	19,0	9,5	28,4	28,4	14	50
T22C1038	10	3/8	19,0	10,5	24,7	24,7	17	50
T22C1012	10	1/2	19,0	13,5	28,2	28,2	21	25
T22C1218	12	1/8	21,5	7,5	28,2	28,2	15	25
T22C1214	12	1/4	21,5	9,5	29,7	29,7	15	25
T22C1238	12	3/8	21,5	10,5	26,0	26,0	21	50
T22C1212	12	1/2	21,5	13,5	29,5	29,5	21	25

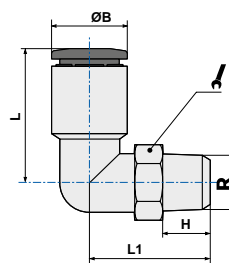

Арт. T22F

Код	ØD	G	A	B	E		
T22F04M5	4	M5	5,5	20,5	19,0	10	50
T22F0418	4	1/8	8,5	24,0	19,0	14	50
T22F0414	4	1/4	11,0	27,0	19,0	17	50
T22F06M5	6	M5	6,0	20,7	19,2	12	50
T22F0618	6	1/8	8,5	24,2	19,2	14	50
T22F0614	6	1/4	11,0	27,2	19,2	17	50
T22F0638	6	3/8	12,0	28,7	19,2	21	25
T22F0818	8	1/8	8,0	27,0	23,0	14	50
T22F0814	8	1/4	11,0	30,5	23,0	17	50
T22F0838	8	3/8	12,0	32,0	23,0	21	25
T22F1014	10	1/4	11,0	34,3	28,2	17	25
T22F1038	10	3/8	12,0	35,8	28,2	21	25
T22F1012	10	1/2	14,0	38,8	28,2	24	10
T22F1214	12	1/4	11,0	37,0	29,5	21	25
T22F1238	12	3/8	12,0	38,0	29,5	21	25
T22F1212	12	1/2	14,0	40,5	29,5	24	10

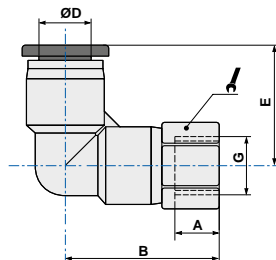

Арт. T22L

Код	ØD	G	ØB	H	L	L1		
T22L04M5	4	M5	11	3,5	34,5	19	10	25
T22L0418	4	1/8	9,5	6	35,7	17,2	13	25
T22L06M5	6	M5	13	3,5	36,4	19,2	12	25
T22L0618	6	1/8	11,5	6	35,7	20,8	13	25
T22L0818	8	1/8	13,5	6	38	23	13	25
T22L0814	8	1/4	15	7,5	44,3	22,5	17	25

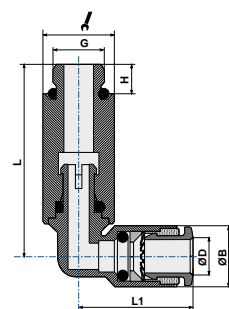

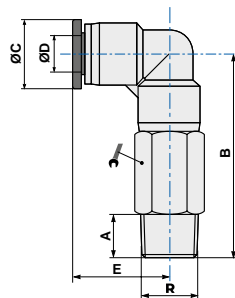

Арт. T22LC

Код	ØD	R	A	B	ØC	E		
T22LC0418	4	1/8	7,5	37	11	19	10	25
T22LC0414	4	1/4	9,5	40	11	19	14	25
T22LC0618	6	1/8	7,5	39,7	13	19,2	12	25
T22LC0614	6	1/4	9,5	42,2	13	19,2	14	25
T22LC0638	6	3/8	10,5	43,7	13	19,2	17	25
T22LC0818	8	1/8	7,5	44,8	14,4	23	14	25
T22LC0814	8	1/4	9,5	46,8	14,4	23	17	25
T22LC0838	8	3/8	10,5	48,5	14,4	23	17	25
T22LC1018	10	1/8	7,5	54,3	18,5	28,2	17	25
T22LC1014	10	1/4	9,5	56,3	18,5	28,2	17	25
T22LC1038	10	3/8	10,5	57,3	18,5	28,2	17	25
T22LC1012	10	1/2	13,5	60,8	18,5	28,2	21	10
T22LC1214	12	1/4	9,5	61,5	21	29,5	21	10
T22LC1238	12	3/8	10,5	62,5	21	29,5	21	10
T22LC1212	12	1/2	13,5	65,5	21,0	29,5	21	10



Арт. T45

Код	ØD	G	L1	L2	L3	L4	ØD1		
T4504M5	4	M5	3,5	22,5	19	39,5	11,3	10	10
T450418	4	G1/8	5,5	25,5	19	42,5	11,3	14	5
T450618	6	G1/8	5,5	25,5	19,2	43,5	13,3	14	5
T450614	6	G1/4	7,5	28	19,2	46	13,3	17	5
T450818	8	G1/8	5,5	29	22,5	49,5	14,8	14	5
T450814	8	G1/4	7,5	31,5	22,5	52	14,8	17	5
T451014	10	G1/4	7,5	36	27,8	62,5	18,7	17	5
T451038	10	G3/8	7,5	36	27,8	62,5	18,7	20	5

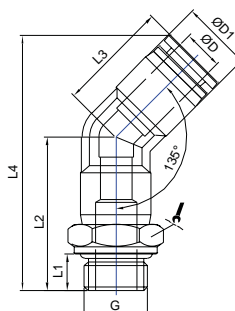

Арт. T23

Код	ØD1	ØD2	ØE	ØB	A	L	
T230400	4	4	2,40	9,5	19	33,0	50
T230406	4	6	2,40	11,5	19	35,8	50
T230600	6	6	2,60	11,5	23	38,6	50
T230608	6	8	3,20	13,5	23	39,8	50
T230800	8	8	2,75	16,5	27	42,5	50
T230810	8	10	3,20	17,0	27	44,4	25
T231000	10	10	4,30	20,0	34	50,8	25
T231012	10	12	4,30	20,0	34	50,8	10
T231200	12	12	4,20	20,0	40	53,2	10

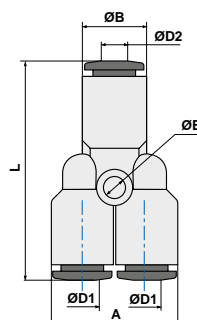

Арт. T23L0

Код	ØD1	ØD2	ØB	A	ØE	L	L1	
T2304L0	4	4	9,5	19	2,4	50	16,7	50
T2306L0	6	6	11,5	23	2,6	58,1	19,5	50
T2308L0	8	8	13,5	27	2,75	63,5	21	50
T2310L0	10	10	17,0	34	4,3	74,8	24	25
T2312L0	12	12	20,0	40	4,2	78,2	25	10

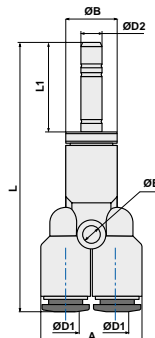

ГИДРАВЛИЧЕСКОЕ ОБОРУДОВАНИЕ

ПНЕВМАТИЧЕСКОЕ ОБОРУДОВАНИЕ

СИСТЕМЫ СМАЗКИ

Арт. T23G

Код	ØD1	ØD2	ØB	A	ØE	L	L1		
T23G04M5	4	M5	2,0	9,5	4,0	19,0	39,1	10	50
T23G0418	4	1/8	3,0	9,5	5,5	19,0	20,5	13	50
T23G0414	4	1/4	3,0	11,0	7,5	22,0	45,5	17	50
T23G0438	4	3/8	3,0	11,0	7,5	22,0	46,0	20	25
T23G0618	6	1/8	5,0	11,5	5,5	23,0	34,8	13	50
T23G0614	6	1/4	5,0	11,5	6,5	23,0	36,4	16	50
T23G0638	6	3/8	5,0	13,0	7,5	26,0	47,2	20	25
T23G0818	8	1/8	7,0	13,5	5,5	27,0	37,5	13	50
T23G0814	8	1/4	7,0	13,5	6,5	27,0	38,6	16	50
T23G0838	8	3/8	6,2	14,4	7,5	29,4	50,5	20	25
T23G1014	10	1/4	8,2	18,4	7,5	36,4	58,9	17	25
T23G1038	10	3/8	8,2	18,4	7,5	36,4	58,9	20	25
T23G1012	10	1/2	8,2	18,4	10	36,4	62,4	24	10
T23G1214	12	1/4	9,5	21,0	7,5	42,0	62,3	21	10
T23G1238	12	3/8	9,5	21,0	7,5	42,0	62,3	21	10
T23G1212	12	1/2	9,5	21,0	10	42,0	65,3	24	10

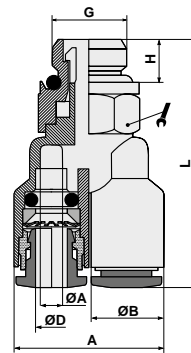

Арт. T24

Код	ØD1	ØD2	ØE	ØB	A max	L	L1		
T240400	4	4	3,2	9,5	20,2	34,5	34,5	25	
T240406	4	6	3,2	13,0	20,8	35,5	35,5	25	
T240408	4	8	3,2	14,5	22,2	38,5	38,5	25	
T240600	6	6	3,2	11,5	23,9	39,6	39,6	25	
T240608	6	8	3,2	13,5	26,15	41,8	41,8	25	
T240800	8	8	3,2	15,0	28,0	42,0	42,0	25	
T240810	8	10	3,2	17,0	28,0	46,5	46,5	25	

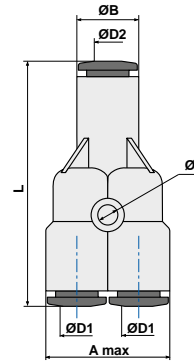

Арт. T24L0

Код	ØD1	ØD2	ØE	ØB	A	L	L1		
T2404L0	4	4	2,4	9,5	19	51,2	16,7	25	
T2406L0	6	6	2,6	11,5	23	59,1	19,5	25	
T2408L0	8	8	2,75	13,5	27	67,5	21	25	

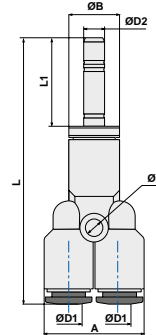

Арт. T33

Код	ØD1	G	ØA	H	L1	L			
T3304M5	4	M5	2	4	28	19,5	2,5	14	25
T330418	4	1/8	5,5	5,5	43,3	21,1	3	14	25
T330618	6	1/8	5,5	5,5	43,3	24,3	3	14	25
T330614	6	1/4	7,8	6,5	50	25,5	4	18	25
T330818	8	1/8	5,5	5,5	43,3	24,8	3	14	25
T330814	8	1/4	7,8	6,5	50	26,5	4	18	25
T331014	10	1/4	7,8	6,5	50	28,4	4	18	25

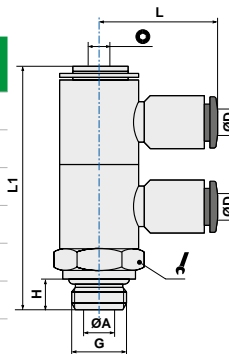

Арт. Т33В

Код	ØD1	G	ØA	H	L1	L	Ø	↶	↷
T33B04M5	4	M5	2	4	28	19,5	2,5	14	10
T33B0618	6	1/8	5,5	5,5	43,3	24,3	3	14	10
T33B0814	8	1/4	7,8	6,5	50	26,5	4	18	10

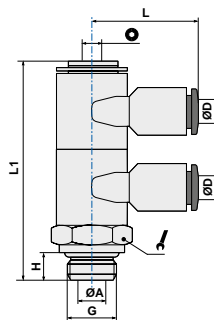

Арт. Т34

Код	ØD	G	ØA	H	L1	L	Ø	↶	↷
T340418	4	1/8	5,5	5,5	58,4	21,1	3	14	10
T340618	6	1/8	5,5	5,5	58,4	24,3	3	14	10
T340818	8	1/8	5,5	5,5	58,4	24,8	3	14	10
T340614	6	1/4	7,8	6,5	67	25,5	4	18	10
T340814	8	1/4	7,8	6,5	67	26,5	4	18	10
T341014	10	1/4	7,8	6,5	67	28,4	4	18	10

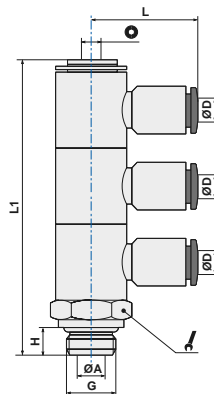

Арт. Т34В

Код	ØD	G	ØA	H	L1	L	Ø	↶	↷
T34B0618	6	1/8	5,5	5,5	58,4	24,3	3	14	10
T34B0814	8	1/4	7,8	6,5	67	26,5	4	18	10

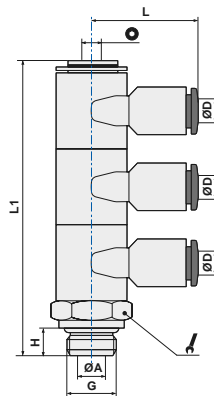

Арт. Т90

Код	ØD	ØD1	L	↷
T900400	4	11,5	17,5	100
T900600	6	13,5	17,7	100
T900800	8	15	21,3	100
T901000	10	19	25	50
T901200	12	21,5	26	50

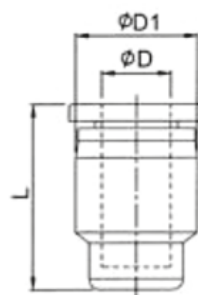

ГИДРАВЛИЧЕСКОЕ ОБОРУДОВАНИЕ

ПНЕВМАТИЧЕСКОЕ ОБОРУДОВАНИЕ

СИСТЕМЫ СМАЗКИ